

Heterojunction Bipolar Transistor (InGaP HBT)

Broadband High Linearity Amplifier

The MMG3010NT1 is a General Purpose Amplifier that is internally input and output matched. It is designed for a broad range of Class A, small-signal, high linearity, general purpose applications. It is suitable for applications with frequencies from 0 to 6000 MHz such as Cellular, PCS, BWA, WLL, PHS, CATV, VHF, UHF, UMTS and general small-signal RF.

Features

- Frequency: 0 to 6000 MHz
- P1dB: 17 dBm @ 900 MHz
- Small-Signal Gain: 15 dB @ 900 MHz
- Third Order Output Intercept Point: 31 dBm @ 900 MHz
- Single 5 Volt Supply
- Internally Matched to 50 Ohms
- Low Cost SOT-89 Surface Mount Package
- RoHS Compliant
- In Tape and Reel. T1 Suffix = 1000 Units per 12 mm, 7 inch Reel.

MMG3010NT1

**0-6000 MHz, 15 dB
17 dBm
InGaP HBT**

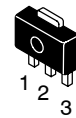

**CASE 1514-02, STYLE 1
SOT-89
PLASTIC**

Table 1. Typical Performance (1)

Characteristic	Symbol	900 MHz	2140 MHz	3500 MHz	Unit
Small-Signal Gain (S21)	G_p	15	14	12	dB
Input Return Loss (S11)	IRL	-15	-17	-22	dB
Output Return Loss (S22)	ORL	-25	-25	-15	dB
Power Output @1dB Compression	P1db	17	16.5	15.5	dBm
Third Order Output Intercept Point	IP3	31	30	28	dBm

1. $V_{CC} = 5$ Vdc, $T_C = 25^\circ\text{C}$, 50 ohm system

Table 2. Maximum Ratings

Rating	Symbol	Value	Unit
Supply Voltage	V_{CC}	7	V
Supply Current	I_{CC}	300	mA
RF Input Power	P_{in}	10	dBm
Storage Temperature Range	T_{stg}	-65 to +150	$^\circ\text{C}$
Junction Temperature (2)	T_J	150	$^\circ\text{C}$

2. For reliable operation, the junction temperature should not exceed 150°C .

Table 3. Thermal Characteristics ($V_{CC} = 5$ Vdc, $I_{CC} = 54$ mA, $T_C = 25^\circ\text{C}$)

Characteristic	Symbol	Value (3)	Unit
Thermal Resistance, Junction to Case	$R_{\theta JC}$	83	$^\circ\text{C/W}$

3. Refer to AN1955, *Thermal Measurement Methodology of RF Power Amplifiers*. Go to <http://www.freescale.com/rf>. Select Documentation/Application Notes - AN1955.

Table 4. Electrical Characteristics ($V_{CC} = 5$ Vdc, 900 MHz, $T_C = 25^\circ\text{C}$, 50 ohm system, in Freescale Application Circuit)

Characteristic	Symbol	Min	Typ	Max	Unit
Small-Signal Gain (S21)	G_p	14	15	—	dB
Input Return Loss (S11)	IRL	—	-15	—	dB
Output Return Loss (S22)	ORL	—	-25	—	dB
Power Output @ 1dB Compression	P1dB	—	17	—	dBm
Third Order Output Intercept Point	IP3	—	31	—	dBm
Noise Figure	NF	—	4.5	—	dB
Supply Current ⁽¹⁾	I_{CC}	46	54	63	mA
Supply Voltage ⁽¹⁾	V_{CC}	—	5	—	V

1. For reliable operation, the junction temperature should not exceed 150°C .

Table 5. Functional Pin Description

Pin Number	Pin Function
1	RF _{in}
2	Ground
3	RF _{out} /DC Supply

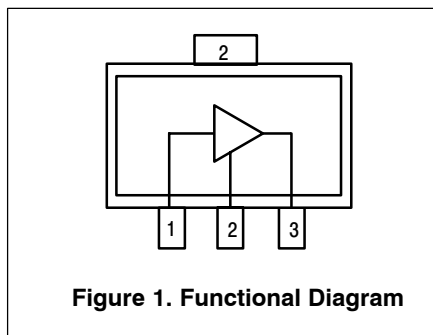

Figure 1. Functional Diagram

Table 6. ESD Protection Characteristics

Test Methodology	Class
Human Body Model (per JESD 22-A114)	1A (Minimum)
Machine Model (per EIA/JESD 22-A115)	A (Minimum)
Charge Device Model (per JESD 22-C101)	IV (Minimum)

Table 7. Moisture Sensitivity Level

Test Methodology	Rating	Package Peak Temperature	Unit
Per JESD 22-A113, IPC/JEDEC J-STD-020	1	260	°C

50 OHM TYPICAL CHARACTERISTICS

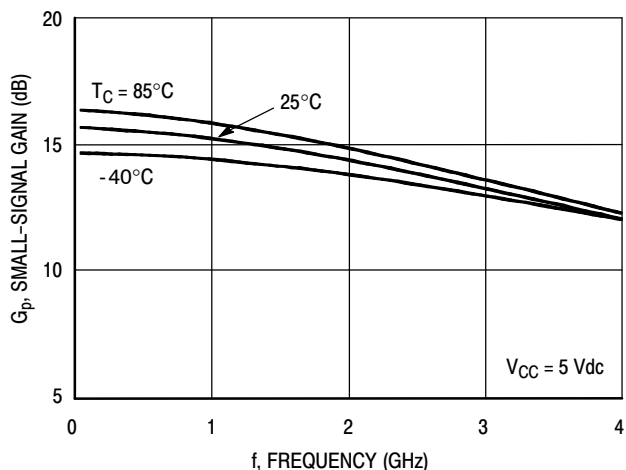

Figure 2. Small-Signal Gain (S21) versus Frequency

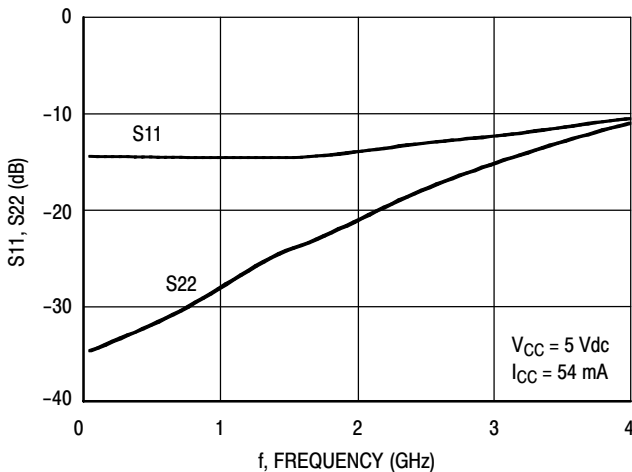

Figure 3. Input/Output Return Loss versus Frequency

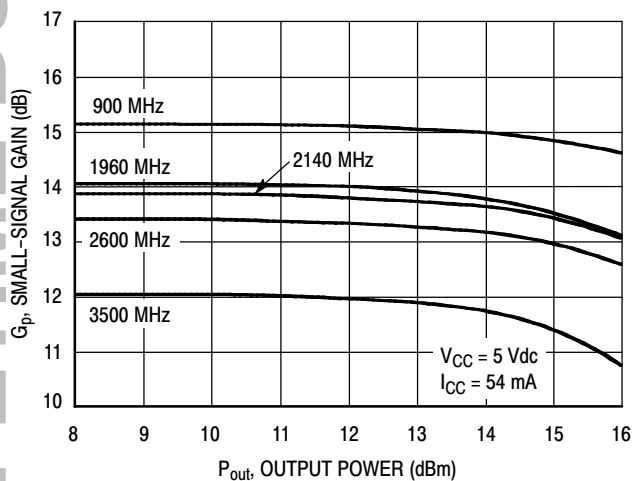

Figure 4. Small-Signal Gain versus Output Power

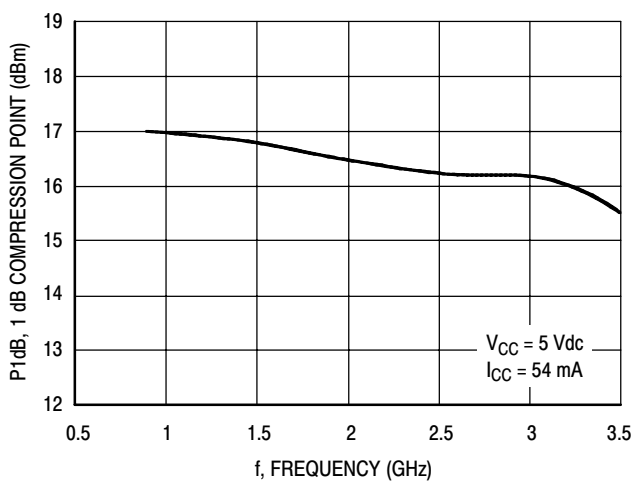

Figure 5. P1dB versus Frequency

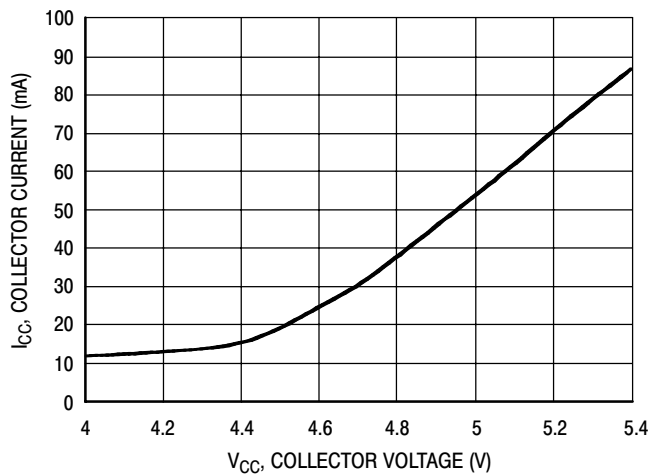

Figure 6. Collector Current versus Collector Voltage

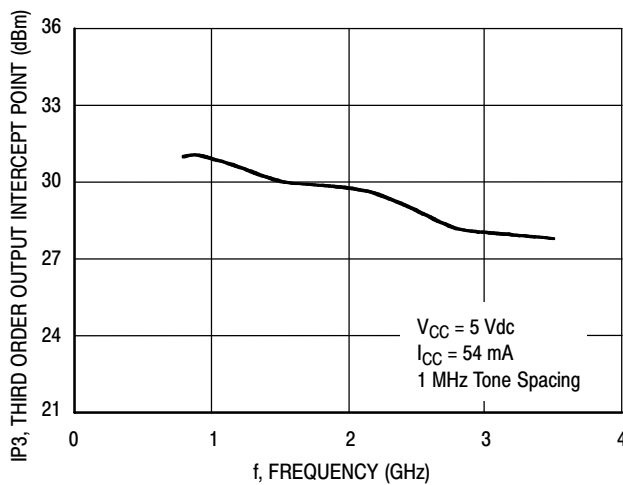

Figure 7. Third Order Output Intercept Point versus Frequency

LIFETIME BUY

LAST ORDER 27 DEC 08 LAST SHIP 27 JUN 09

50 OHM TYPICAL CHARACTERISTICS

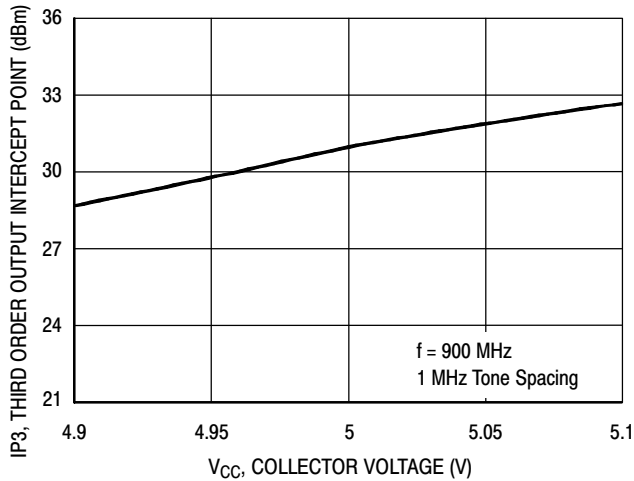

Figure 8. Third Order Output Intercept Point versus Collector Voltage

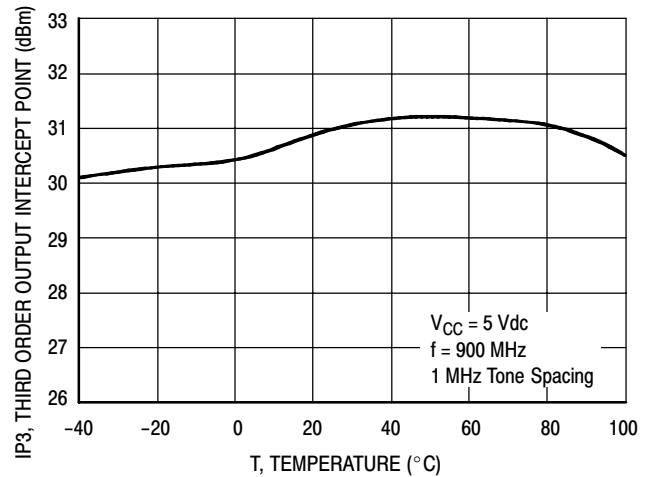

Figure 9. Third Order Output Intercept Point versus Case Temperature

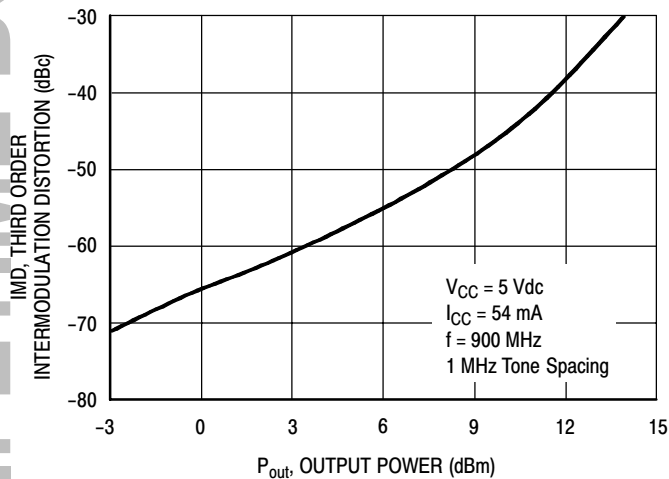
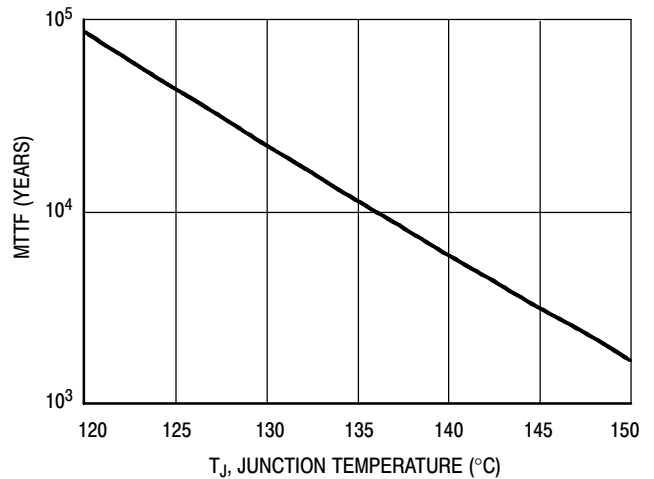

Figure 10. Third Order Intermodulation versus Output Power



NOTE: The MTTF is calculated with $V_{CC} = 5 \text{ Vdc}$, $I_{CC} = 54 \text{ mA}$

Figure 11. MTTF versus Junction Temperature

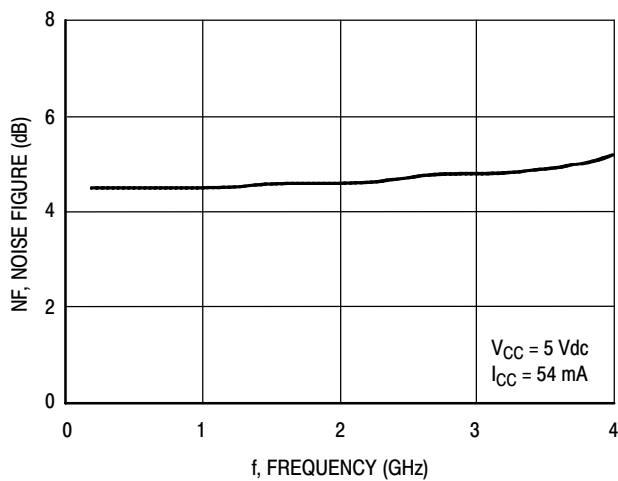

Figure 12. Noise Figure versus Frequency

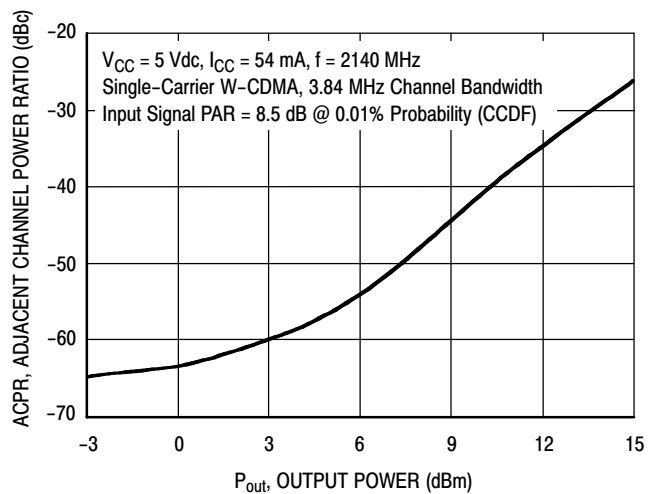

Figure 13. Single-Carrier W-CDMA Adjacent Channel Power Ratio versus Output Power

LIFETIME BUY

LAST ORDER 27 DEC 08 LAST SHIP 27 JUN 09

50 OHM APPLICATION CIRCUIT: 40-300 MHz

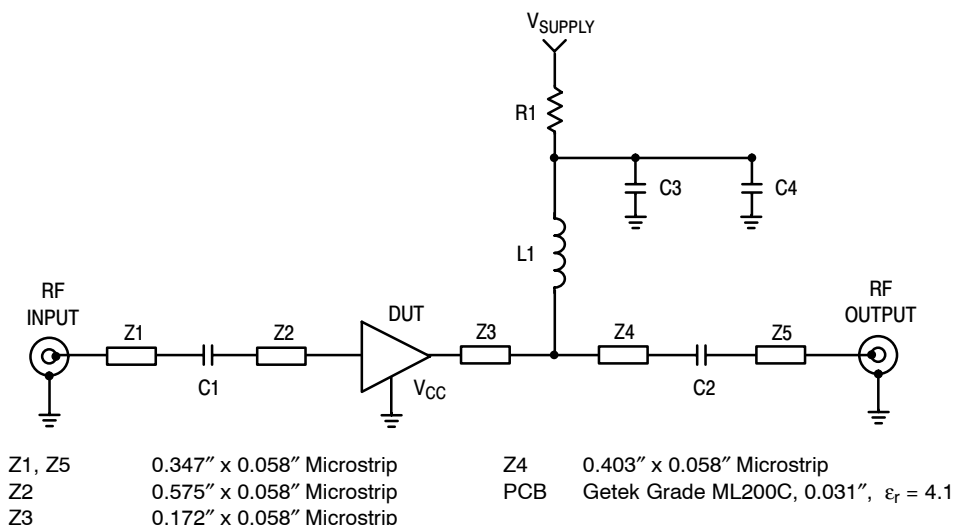

Figure 14. 50 Ohm Test Circuit Schematic

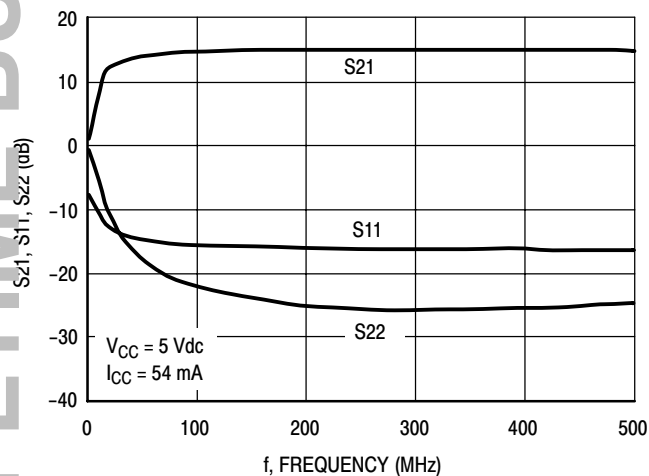

Figure 15. S21, S11 and S22 versus Frequency

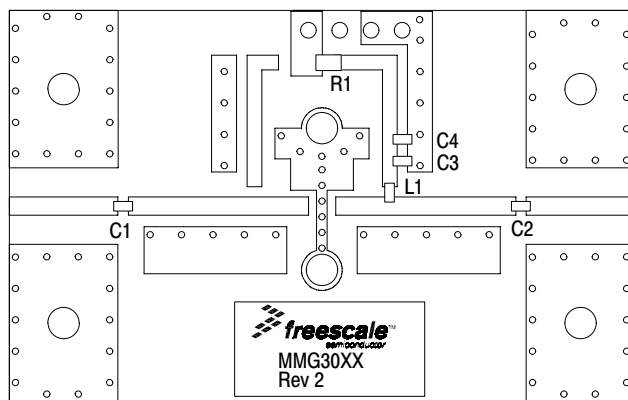

Figure 16. 50 Ohm Test Circuit Component Layout

Table 8. 50 Ohm Test Circuit Component Designations and Values

Part	Description	Part Number	Manufacturer
C1, C2, C3	0.01 μ F Chip Capacitors	C0603C103J5RAC	Kemet
C4	1000 pF Chip Capacitor	C0603C102J5RAC	Kemet
L1	470 nH Chip Inductor	BK2125HM471 - T	Taiyo Yuden
R1	0 Ω Chip Resistor	ERJ3GEY0R00V	Panasonic

LIFETIME BUY

LAST ORDER 27 DEC 08 LAST SHIP 27 JUN 09

50 OHM APPLICATION CIRCUIT: 300-3600 MHz

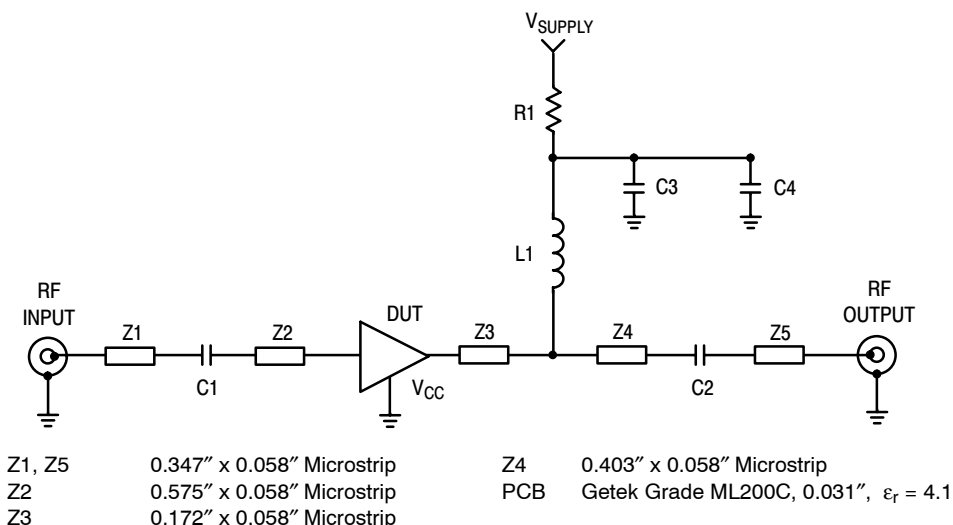

Figure 17. 50 Ohm Test Circuit Schematic

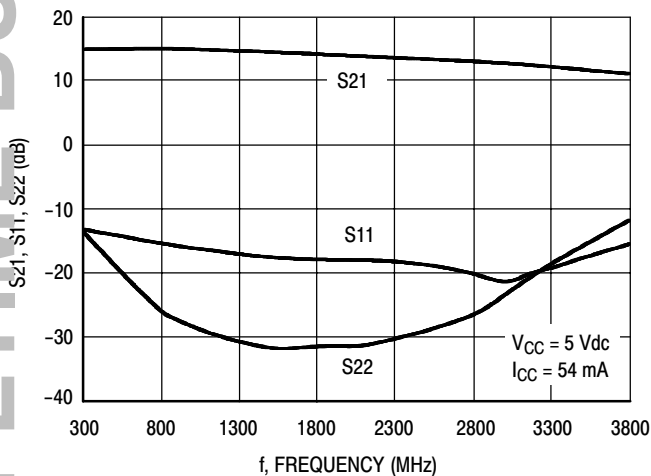

Figure 18. S21, S11 and S22 versus Frequency

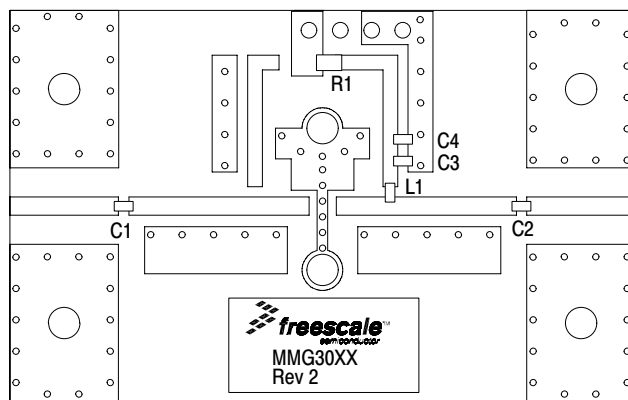

Figure 19. 50 Ohm Test Circuit Component Layout

Table 9. 50 Ohm Test Circuit Component Designations and Values

Part	Description	Part Number	Manufacturer
C1, C2	150 pF Chip Capacitors	C0603C151J5RAC	Kemet
C3	0.01 μ F Chip Capacitor	C0603C103J5RAC	Kemet
C4	1000 pF Chip Capacitor	C0603C102J5RAC	Kemet
L1	56 nH Chip Inductor	HK160856NJ-T	Taiyo Yuden
R1	0 Ω Chip Resistor	ERJ3GEY0R00V	Panasonic

LIFETIME BUY

LAST ORDER 27 DEC 08 LAST SHIP 27 JUN 09

50 OHM TYPICAL CHARACTERISTICS

Table 10. Common Emitter S-Parameters ($V_{CC} = 5 \text{ Vdc}$, $I_{CC} = 54 \text{ mA}$, $T_C = 25^\circ\text{C}$, 50 Ohm System)

f MHz	S ₁₁		S ₂₁		S ₁₂		S ₂₂	
	S ₁₁	∠φ	S ₂₁	∠φ	S ₁₂	∠φ	S ₂₂	∠φ
100	0.18961	174.356	6.08599	176.121	0.10045	-1.147	0.01890	-117.716
150	0.18946	172.591	6.06991	173.709	0.10051	-1.684	0.01961	-119.073
200	0.18931	170.087	6.05558	171.476	0.10055	-2.764	0.02022	-121.834
250	0.18916	168.286	6.04027	169.492	0.10060	-3.23	0.02108	-123.647
300	0.18900	166.103	6.03125	167.447	0.10065	-3.883	0.02178	-125.155
350	0.18887	163.926	6.01832	165.299	0.10069	-4.61	0.02240	-127.572
400	0.18873	161.691	6.00664	163.288	0.10073	-5.218	0.02324	-129.668
450	0.18856	159.363	5.99750	161.184	0.10078	-5.914	0.02417	-131.224
500	0.18844	157.207	5.98612	159.055	0.10085	-6.577	0.02490	-133.739
550	0.18829	154.948	5.97231	157.036	0.10090	-7.176	0.02589	-135.854
600	0.18813	152.775	5.95537	154.979	0.10098	-7.816	0.02683	-137.345
650	0.18799	150.556	5.94078	152.921	0.10111	-8.444	0.02784	-139.784
700	0.18783	148.43	5.92660	150.895	0.10103	-9.124	0.02895	-141.384
750	0.18769	146.278	5.90891	148.835	0.10115	-9.76	0.03030	-143.84
800	0.18753	144.103	5.88998	146.803	0.10113	-10.388	0.03176	-145.852
850	0.18738	142.071	5.86905	144.751	0.10130	-11.106	0.03328	-147.52
900	0.18723	140.126	5.84578	142.751	0.10126	-11.715	0.03472	-148.773
950	0.18703	138.174	5.82588	140.772	0.10142	-12.347	0.03683	-150.721
1000	0.18689	136.334	5.80670	138.776	0.10134	-13.049	0.03847	-153.215
1050	0.18674	134.574	5.77963	136.782	0.10156	-13.635	0.04077	-155.358
1100	0.18657	132.862	5.75495	134.777	0.10146	-14.317	0.04304	-159.06
1150	0.18643	131.57	5.72982	132.79	0.10159	-14.945	0.04551	-162.691
1200	0.18629	130.147	5.70191	130.817	0.10169	-15.594	0.04827	-166.671
1250	0.18613	128.841	5.67762	128.866	0.10184	-16.271	0.05112	-170.497
1300	0.18599	127.621	5.65132	126.933	0.10183	-16.958	0.05460	-174.453
1350	0.18582	126.515	5.62394	124.986	0.10196	-17.615	0.05759	-178.275
1400	0.18568	125.418	5.59479	123.074	0.10201	-18.236	0.06146	-178.051
1450	0.18567	124.471	5.56625	121.175	0.10211	-18.888	0.06306	-174.258
1500	0.18569	123.602	5.54822	119.257	0.10220	-19.552	0.06362	-170.85
1550	0.18591	122.392	5.52432	117.274	0.10258	-20.344	0.06362	-163.521
1600	0.18645	120.668	5.49674	115.354	0.10272	-20.962	0.06377	-160.673
1650	0.18767	119.047	5.46526	113.429	0.10283	-21.702	0.06570	-158.125
1700	0.18855	117.338	5.43646	111.53	0.10301	-22.327	0.06858	-155.716
1750	0.19030	115.719	5.40925	109.673	0.10315	-23.09	0.07094	-153.133
1800	0.19186	114.043	5.38177	107.795	0.10333	-23.804	0.07392	-151.055
1850	0.19364	112.379	5.35341	105.878	0.10340	-24.547	0.07711	-148.881
1900	0.19581	110.938	5.32341	104.011	0.10356	-25.192	0.08039	-147.016
1950	0.19775	109.449	5.29221	102.117	0.10384	-25.884	0.08395	-145.259
2000	0.20022	108.079	5.25998	100.28	0.10401	-26.62	0.08764	-143.574
2050	0.20274	106.526	5.22900	98.422	0.10405	-27.296	0.09155	-141.882
2100	0.20483	105.054	5.20224	96.556	0.10413	-28.065	0.09523	-140.434
2150	0.20673	103.673	5.16895	94.728	0.10441	-28.819	0.09969	-138.992
2200	0.21006	102.263	5.13639	92.885	0.10441	-29.517	0.10388	-137.594
2250	0.21183	100.83	5.10466	91.074	0.10468	-30.238	0.10812	-136.199

(continued)

50 OHM TYPICAL CHARACTERISTICS

Table 10. Common Emitter S-Parameters ($V_{CC} = 5 \text{ Vdc}$, $I_{CC} = 54 \text{ mA}$, $T_C = 25^\circ\text{C}$, 50 Ohm System) (continued)

f MHz	S ₁₁		S ₂₁		S ₁₂		S ₂₂	
	S ₁₁	∠φ	S ₂₁	∠φ	S ₁₂	∠φ	S ₂₂	∠φ
2300	0.21443	99.385	5.07001	89.25	0.10472	-30.97	0.11217	134.891
2350	0.21661	98.005	5.03818	87.453	0.10489	-31.768	0.11632	133.499
2400	0.21882	96.635	5.00516	85.611	0.10502	-32.469	0.12050	132.176
2450	0.22193	95.395	4.97224	83.821	0.10521	-33.265	0.12557	130.946
2500	0.22303	93.907	4.93831	82.052	0.10527	-34.008	0.12957	129.503
2550	0.22524	92.5	4.90747	80.256	0.10541	-34.706	0.13384	128.151
2600	0.22731	91.106	4.87540	78.504	0.10567	-35.467	0.13842	126.605
2650	0.22921	89.599	4.84438	76.72	0.10587	-36.255	0.14269	125.06
2700	0.23072	88.26	4.81170	74.931	0.10582	-37.021	0.14690	123.585
2750	0.23259	86.873	4.77720	73.147	0.10600	-37.804	0.15188	122.036
2800	0.23443	85.515	4.74514	71.382	0.10623	-38.579	0.15645	120.364
2850	0.23625	84.122	4.71210	69.615	0.10637	-39.349	0.16075	118.48
2900	0.23786	82.84	4.68334	67.904	0.10648	-40.152	0.16529	116.779
2950	0.23979	81.448	4.64992	66.078	0.10664	-41.004	0.16969	114.827
3000	0.24125	80.072	4.61988	64.334	0.10700	-41.819	0.17439	112.861
3050	0.24422	78.711	4.58846	62.607	0.10702	-42.586	0.17909	111.23
3100	0.24610	77.547	4.55812	60.863	0.10736	-43.392	0.18404	109.114
3150	0.24792	76.337	4.52495	59.115	0.10733	-44.248	0.18914	107.101
3200	0.25072	75.174	4.49699	57.356	0.10748	-45.078	0.19427	105.076
3250	0.25383	73.947	4.46681	55.612	0.10765	-45.892	0.19983	102.924
3300	0.25590	72.848	4.43561	53.877	0.10784	-46.753	0.20478	100.877
3350	0.25874	71.738	4.40430	52.133	0.10813	-47.687	0.21036	98.897
3400	0.26159	70.666	4.37458	50.384	0.10814	-48.565	0.21586	96.818
3450	0.26531	69.68	4.34458	48.649	0.10821	-49.382	0.22115	94.763
3500	0.26829	68.707	4.31385	46.916	0.10846	-50.314	0.22678	92.769
3550	0.27180	67.687	4.28470	45.167	0.10856	-51.229	0.23264	90.836
3600	0.27525	66.773	4.25389	43.44	0.10871	-52.108	0.23850	88.858

LIFETIME BUY

LAST ORDER 27 DEC 08 LAST SHIP 27 JUN 09

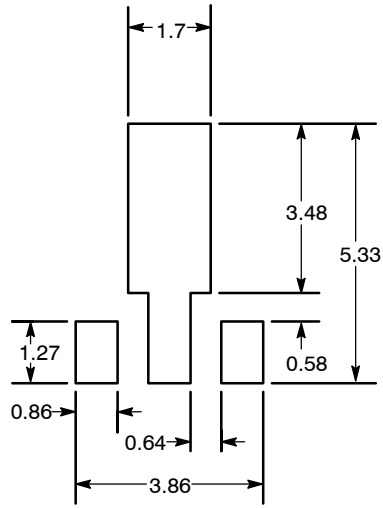

Recommended Solder Stencil

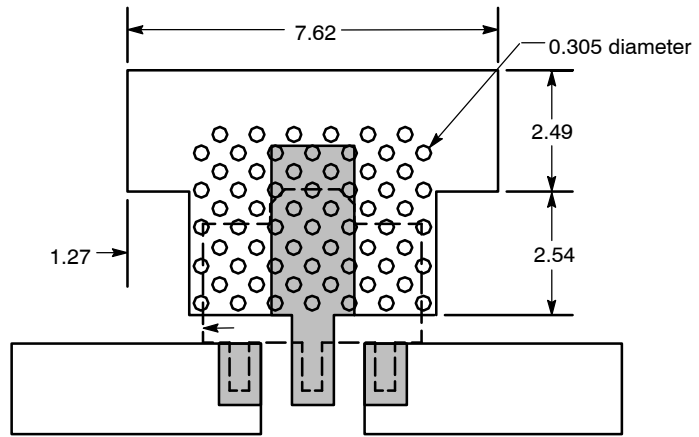

NOTES:

1. THERMAL AND RF GROUNDING CONSIDERATIONS SHOULD BE USED IN PCB LAYOUT DESIGN.
2. DEPENDING ON PCB DESIGN RULES, AS MANY VIAS AS POSSIBLE SHOULD BE PLACED ON THE LANDING PATTERN.
3. IF VIAS CANNOT BE PLACED ON THE LANDING PATTERN, THEN AS MANY VIAS AS POSSIBLE SHOULD BE PLACED AS CLOSE TO THE LANDING PATTERN AS POSSIBLE FOR OPTIMAL THERMAL AND RF PERFORMANCE.
4. RECOMMENDED VIA PATTERN SHOWN HAS 0.381 x 0.762 MM PITCH.

Figure 20. Recommended Mounting Configuration

PACKAGE DIMENSIONS

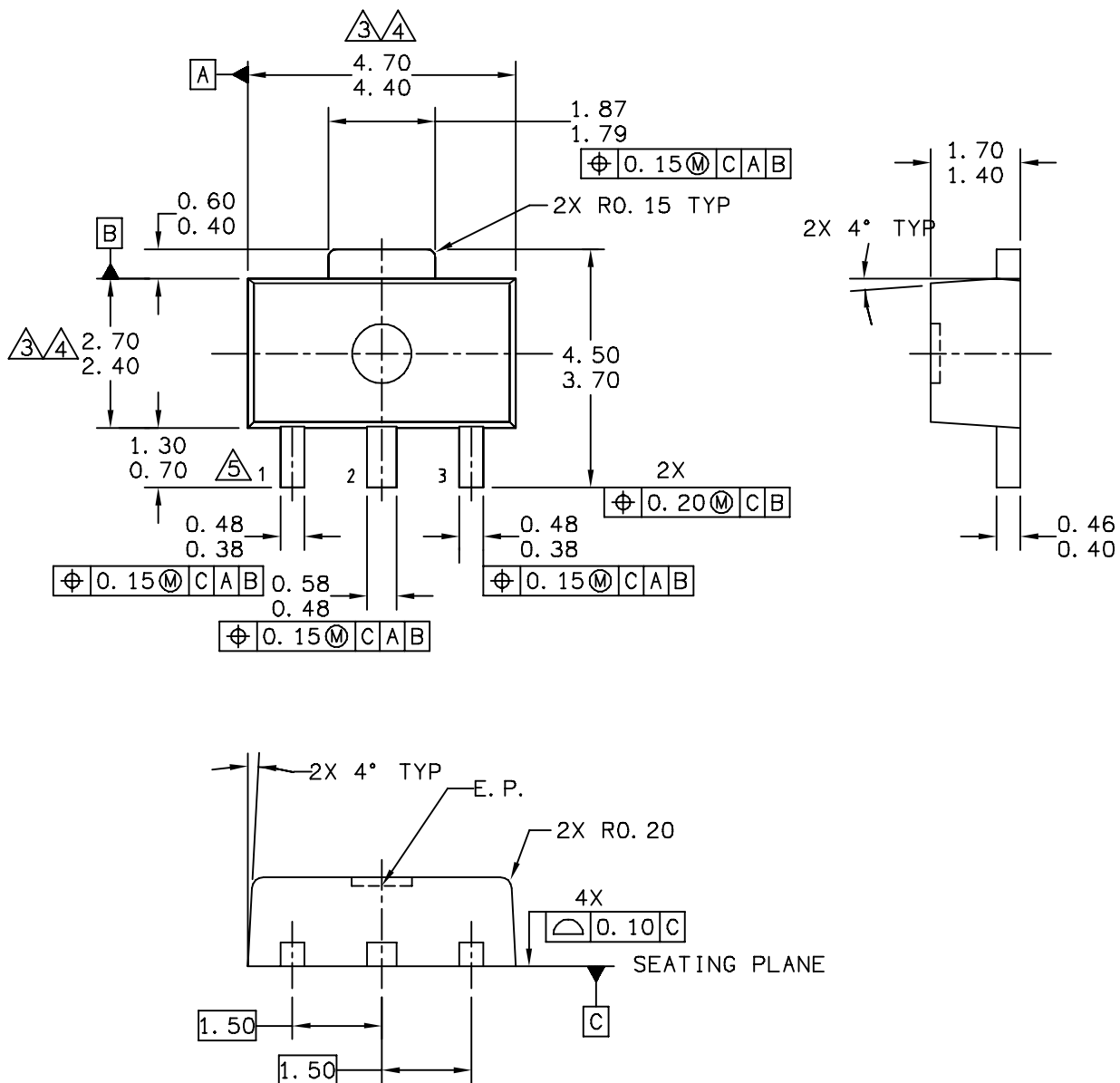

© FREESCALE SEMICONDUCTOR, INC. ALL RIGHTS RESERVED.	MECHANICAL OUTLINE	PRINT VERSION NOT TO SCALE	
TITLE: SOT-89, 4 LEAD, 4.5 X 2.5 PKG, 1.5 MM PITCH	DOCUMENT NO: 98ASA10586D	REV: D	
	CASE NUMBER: 1514-02	27 JUN 2007	
	STANDARD: NON-JEDEC		

MMG3010NT1

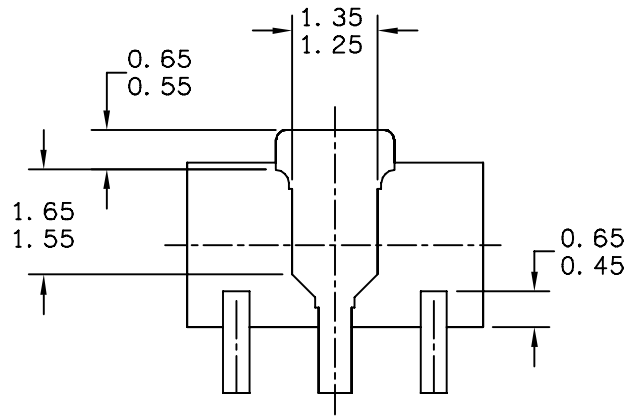

BOTTOM VIEW

CASE STYLE:

STYLE 1:

PIN 1. RF INPUT
 PIN 2. GROUND
 PIN 3. RF OUTPUT

STYLE 2:

PIN 1. GATE
 PIN 2. SOURCE
 PIN 3. DRAIN

© FREESCALE SEMICONDUCTOR, INC. ALL RIGHTS RESERVED.	MECHANICAL OUTLINE	PRINT VERSION NOT TO SCALE	
TITLE: SOT-89, 4 LEAD, 4.5 X 2.5 PKG, 1.5 MM PITCH	DOCUMENT NO: 98ASA10586D	REV: D	
	CASE NUMBER: 1514-02	27 JUN 2007	
	STANDARD: NON-JEDEC		

NOTES:

1 DIMENSIONING AND TOLERANCING PER ASME Y14.5M – 1994.

2 ALL DIMENSIONS ARE IN MILLIMETERS.

3 DIMENSIONS DOES NOT INCLUDE MOLD FLASH, PROTRUSIONS OR GATE BURRS. MOLD FLASH, PROTRUSIONS OR GATE BURRS SHALL NOT EXCEED 0.5mm PER END. DIMENSION DOES NOT INCLUDE INTERLEAD FLASH OR PROTRUSION. INTERLEAD FLASH OR PROTRUSION SHALL NOT EXCEED 0.5 mm PER SIDE.

4 DIMENSION ARE DETERMINED AT THE OUTMOST EXTREMES OF THE PLASTIC BODY EXCLUSIVE OF MOLD FLASH, TIE BAR BURRS, GATE BURRS AND INTERLEAD FLASH, BUT INCLUDING ANY MISMATCH BETWEEN THE TOP AND BOTTOM OF THE PLASTIC BODY.

5 TERMINAL NUMBERS ARE SHOWN FOR REFERENCE ONLY.

© FREESCALE SEMICONDUCTOR, INC. ALL RIGHTS RESERVED.	MECHANICAL OUTLINE	PRINT VERSION NOT TO SCALE	
TITLE: SOT-89, 4 LEAD, 4.5 X 2.5 PKG, 1.5 MM PITCH	DOCUMENT NO: 98ASA10586D	REV: D	
	CASE NUMBER: 1514-02	27 JUN 2007	
	STANDARD: NON-JEDEC		

PRODUCT DOCUMENTATION

Refer to the following documents to aid your design process.

Application Notes

- AN1955: Thermal Measurement Methodology of RF Power Amplifiers
- AN3100: General Purpose Amplifier Biasing

REVISION HISTORY

The following table summarizes revisions to this document.

Revision	Date	Description
3	Mar. 2007	<ul style="list-style-type: none">• Corrected and updated Part Numbers in Tables 8 and 9, Component Designations and Values, to RoHS compliant part numbers, p. 6, 7
4	July 2007	<ul style="list-style-type: none">• Replaced Case Outline 1514-01 with 1514-02, Issue D, p. 1, 11-13. Case updated to add missing dimension for Pin 1 and Pin 3.
5	Mar. 2008	<ul style="list-style-type: none">• Removed Footnote 2, Continuous voltage and current applied to device, from Table 2, Maximum Ratings, p. 1• Corrected Fig. 13, Single-Carrier W-CDMA Adjacent Channel Power Ratio versus Output Power y-axis (ACPR) unit of measure to dBc, p. 5• Corrected S-Parameter table frequency column label to read "MHz" versus "GHz" and corrected frequency values from GHz to MHz, p. 8, 9

How to Reach Us:

Home Page:

www.freescale.com

Web Support:

<http://www.freescale.com/support>

USA/Europe or Locations Not Listed:

Freescale Semiconductor, Inc.
Technical Information Center, EL516
2100 East Elliot Road
Tempe, Arizona 85284
+1-800-521-6274 or +1-480-768-2130
www.freescale.com/support

Europe, Middle East, and Africa:

Freescale Halbleiter Deutschland GmbH
Technical Information Center
Schatzbogen 7
81829 Muenchen, Germany
+44 1296 380 456 (English)
+46 8 52200080 (English)
+49 89 92103 559 (German)
+33 1 69 35 48 48 (French)
www.freescale.com/support

Japan:

Freescale Semiconductor Japan Ltd.
Headquarters
ARCO Tower 15F
1-8-1, Shimo-Meguro, Meguro-ku,
Tokyo 153-0064
Japan
0120 191014 or +81 3 5437 9125
support.japan@freescale.com

Asia/Pacific:

Freescale Semiconductor China Ltd.
Exchange Building 23F
No. 118 Jianguo Road
Chaoyang District
Beijing 100022
China
+86 010 5879 8000
support.asia@freescale.com

For Literature Requests Only:

Freescale Semiconductor Literature Distribution Center
P.O. Box 5405
Denver, Colorado 80217
1-800-441-2447 or 303-675-2140
Fax: 303-675-2150
LDCForFreescaleSemiconductor@hibbertgroup.com

Information in this document is provided solely to enable system and software implementers to use Freescale Semiconductor products. There are no express or implied copyright licenses granted hereunder to design or fabricate any integrated circuits or integrated circuits based on the information in this document.

Freescale Semiconductor reserves the right to make changes without further notice to any products herein. Freescale Semiconductor makes no warranty, representation or guarantee regarding the suitability of its products for any particular purpose, nor does Freescale Semiconductor assume any liability arising out of the application or use of any product or circuit, and specifically disclaims any and all liability, including without limitation consequential or incidental damages. "Typical" parameters that may be provided in Freescale Semiconductor data sheets and/or specifications can and do vary in different applications and actual performance may vary over time. All operating parameters, including "Typicals", must be validated for each customer application by customer's technical experts. Freescale Semiconductor does not convey any license under its patent rights nor the rights of others. Freescale Semiconductor products are not designed, intended, or authorized for use as components in systems intended for surgical implant into the body, or other applications intended to support or sustain life, or for any other application in which the failure of the Freescale Semiconductor product could create a situation where personal injury or death may occur. Should Buyer purchase or use Freescale Semiconductor products for any such unintended or unauthorized application, Buyer shall indemnify and hold Freescale Semiconductor and its officers, employees, subsidiaries, affiliates, and distributors harmless against all claims, costs, damages, and expenses, and reasonable attorney fees arising out of, directly or indirectly, any claim of personal injury or death associated with such unintended or unauthorized use, even if such claim alleges that Freescale Semiconductor was negligent regarding the design or manufacture of the part.

Freescale™ and the Freescale logo are trademarks of Freescale Semiconductor, Inc. All other product or service names are the property of their respective owners.

© Freescale Semiconductor, Inc. 2005-2008. All rights reserved.

